



TRM-315-LT
TRM-418-LT
TRM-433-LT



LT SERIES TRANSCEIVER MODULE DATA GUIDE

DESCRIPTION

The LT Series transceiver is ideal for the bi-directional wireless transfer of serial data, control, or command information in the favorable 260-470MHz band. The transceiver is capable of generating +10dBm into a 50-ohm load and achieves an outstanding typical sensitivity of -112dBm. Its advanced synthesized architecture delivers outstanding stability and frequency accuracy, and minimizes the effects of antenna pulling. When paired, the transceivers form a reliable wireless link that is capable of transferring data at rates of up to 10,000bps over distances of up to 3,000 feet.

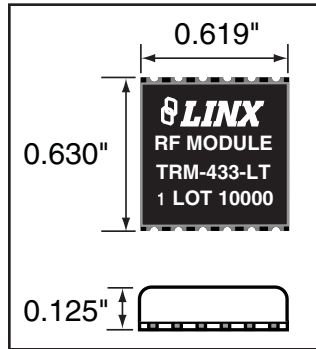

Figure 1: Package Dimensions

Applications operating over shorter distances or at lower data rates will also benefit from increased link reliability and superior noise immunity. Housed in a tiny reflow-compatible SMD package, the transceiver requires no external RF components (except an antenna), which greatly simplifies integration and lowers assembly costs.

FEATURES

- Long range
- Low cost
- PLL-synthesized architecture
- Direct serial interface
- Data rates to 10,000bps
- No external RF components required
- Low power consumption
- Compact surface-mount package
- Wide temperature range
- RSSI and power-down functions
- No production tuning
- Easy to use

APPLICATIONS INCLUDE

- 2-Way Remote Control
- Keyless Entry
- Garage / Gate Openers
- Lighting Control
- Medical Monitoring / Call Systems
- Remote Industrial Monitoring
- Periodic Data Transfer
- Home / Industrial Automation
- Fire / Security Alarms / Access Control
- Remote Status / Position Sensing
- Long-Range RFID
- Wire Elimination

ORDERING INFORMATION

PART #	DESCRIPTION
TRM-315-LT	Transceiver 315MHz
TRM-418-LT	Transceiver 418MHz
TRM-433-LT	Transceiver 433MHz
EVAL-***-LT	Basic Evaluation Kit
*** = Frequency	
Transceivers are supplied in tubes of 33 pcs.	

ELECTRICAL SPECIFICATIONS

Parameter	Designation	Min.	Typical	Max.	Units	Notes
POWER SUPPLY						
Operating Voltage	V _{CC}	2.1	3.0	3.6	VDC	–
Supply Current	I _{CC}					
Transmit Mode Logic High		–	12	14	mA	1
Transmit Mode Logic High		–	7.6	9.5	mA	2
Transmit Mode Logic Low		–	4.0	5.0	mA	–
Receive Mode		–	6.1	7.9	mA	–
Power Down Current	I _{PDN}	–	11.5	20.0	µA	9,10
DATA Line:						
Output Low Voltage	V _{OL}	–	0.15	–	VDC	3
Output High Voltage	V _{OH}	–	V _{CC} -0.26	–	VDC	4
Input Low Threshold	V _{IL}	–	–	0.1V _{CC}	VDC	5
Input High Threshold	V _{IH}	0.9V _{CC}	–	–	VDC	–
Power Down Input:						
Input Low Threshold	V _{IL}	–	–	0.1V _{CC}	VDC	5
Input High Threshold	V _{IH}	0.9V _{CC}	–	–	VDC	–
RF SECTION						
Frequency Range:	F _C					
TRM-315-LT		–	315	–	MHz	–
TRM-418-LT		–	418	–	MHz	–
TRM-433-LT		–	433.92	–	MHz	–
Center Frequency Accuracy	–	–50	–	+50	kHz	–
Data Rate	–	65	–	10,000	bps	–
RECEIVER SECTION						
LO Feedthrough	–	–	-80	–	dBm	6,9
IF Frequency	F _{IF}	–	10.7	–	MHz	9
Noise Bandwidth	N _{3DB}	–	280	–	kHz	9
Receiver Sensitivity	–	-108	-112	-118	dBm	7
RSSI / Analog:						
Dynamic Range	–	–	80	–	dB	9
Analog Bandwidth	–	20	–	5,000	Hz	9
Gain	–	–	15	–	mV / dB	9
Voltage with No Carrier	–	–	430	–	mV	9
TRANSMITTER SECTION						
Output Power	P _O	–	+9.2	+11	dBm	1,6
With a 750Ω resistor on LADJ	P _O	-4	0.0	+4	dBm	2,6
Output Power Control Range	–	-30	–	MAX	dB	9
Harmonic Emissions	P _H	–	–	-36	dBc	6
ANTENNA PORT						
RF Input Impedance	R _{IN}	–	50	–	Ω	9
TIMING						
Receiver Turn-On Time:						
Via V _{CC}	–	–	2.2	–	mSec	8,9
Via PDN	–	–	0.25	–	mSec	8,9
Max. Time Between Transitions	–	–	15.0	–	mSec	9
Transmitter Turn-On Time:						
Via V _{CC}	–	–	2.0	–	mSec	9
Via PDN	–	–	–	500	µSec	9
Modulation Delay	–	–	–	30.0	nS	9
Transmit to Receive Switch Time	–	–	180	400	µSec	9
Receive to Transmit Switch Time	–	–	490	1000	µSec	9
Dwell Time	–	290	–	–	µSec	9,11
ENVIRONMENTAL						
Operating Temperature Range	–	-40	–	+85	°C	9

ELECTRICAL SPECIFICATIONS

Notes

1. With a 0Ω resistor on LADJ.
2. With a 750Ω resistor on LADJ.
3. I_{SINK} = 500µA.
4. I_{SOURCE} = 500µA.
5. I_{SINK} = 20µA.
6. Into a 50-ohm load.
7. With a 50% square wave at 1,000bps.
8. Time to valid data output.
9. Characterized, but not tested.
10. Receive Mode on power down (see Using the PDN Line section)
11. Minimum time before mode change.

ABSOLUTE MAXIMUM RATINGS

Supply Voltage V _{CC}	-0.3	to	+4.0	VDC
Any Input or Output Pin	-0.3	to	V _{CC} +0.3	VDC
RF Input			0	dBm
Operating Temperature	-40	to	+85	°C
Storage Temperature	-65	to	+150	°C
Soldering Temperature			+260°C for 10 seconds	

NOTE Exceeding any of the limits of this section may lead to permanent damage to the device. Furthermore, extended operation at these maximum ratings may reduce the life of this device.

PERFORMANCE DATA

These performance parameters are based on module operation at 25°C from a 3.0VDC supply unless otherwise noted. Figure 2 illustrates the connections necessary for testing and operation. It is recommended all ground pins be connected to the ground plane. The pins marked NC have no electrical connection.

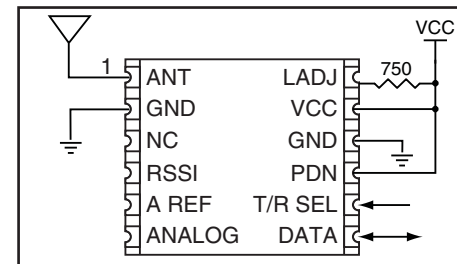

Figure 2: Test / Basic Application Circuit

CAUTION

This product incorporates numerous static-sensitive components. Always wear an ESD wrist strap and observe proper ESD handling procedures when working with this device. Failure to observe this precaution may result in module damage or failure.

TYPICAL PERFORMANCE GRAPHS

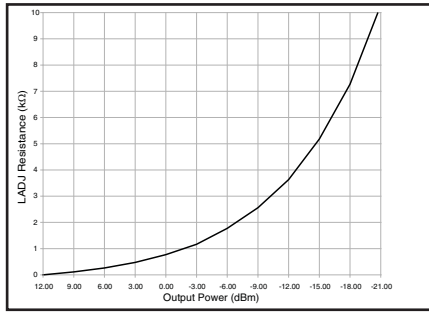

Figure 3: Output Power vs. LADJ Resistance

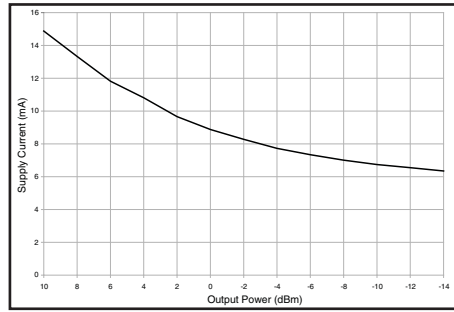

Figure 4: Output Power vs. Current Consumption

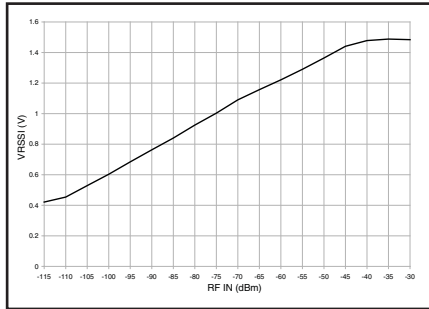

Figure 5: RSSI Curve

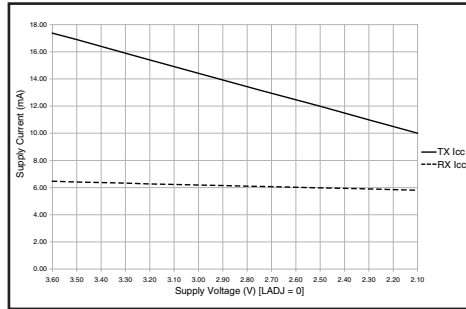

Figure 6: Current Consumption vs. Supply

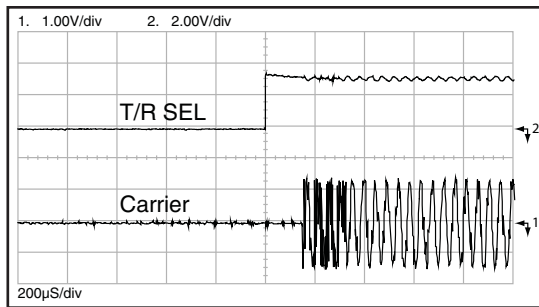

Figure 7: RX to TX Change Time

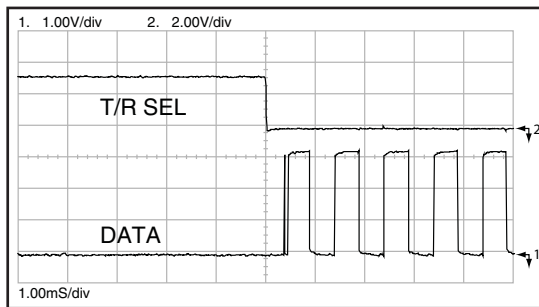

Figure 8: TX to RX Change Time

TYPICAL PERFORMANCE GRAPHS

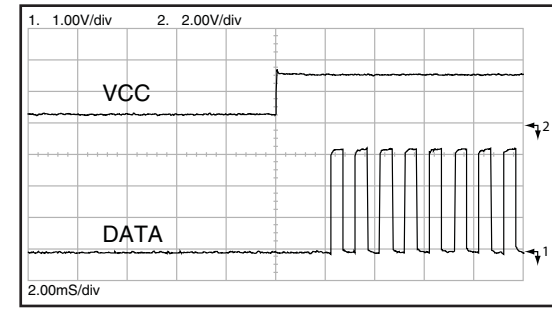

Figure 9: RX Turn-On Time from V_{CC}

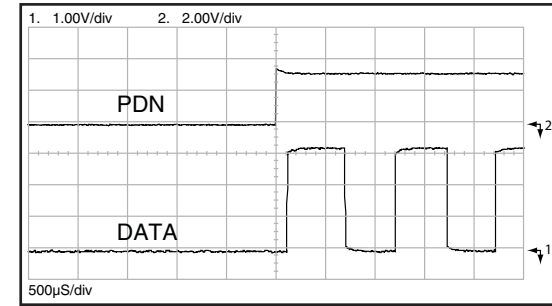

Figure 10: RX Turn-On Time from PDN

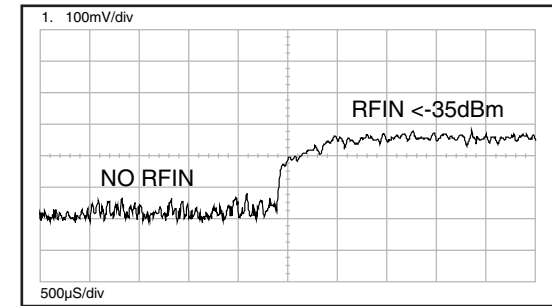

Figure 11: RSSI Response Time

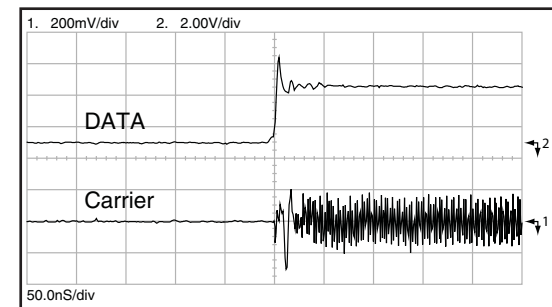

Figure 12: TX Modulation Delay

TYPICAL PERFORMANCE GRAPHS

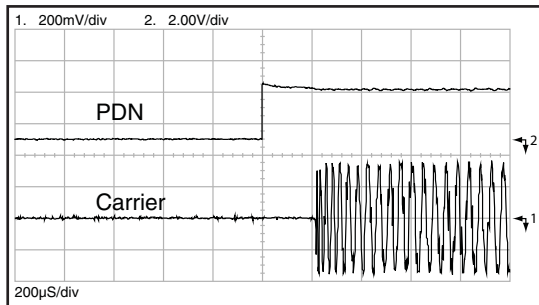

Figure 13: TX Turn-On Time from PDN

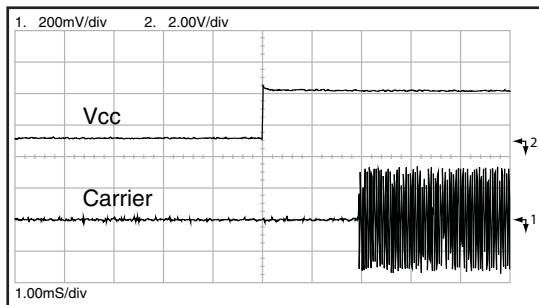

Figure 14: TX Turn-On Time from V_{CC}

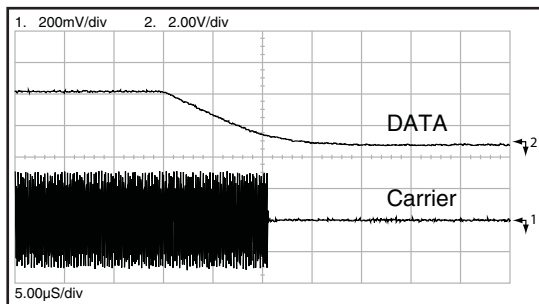

Figure 15: TX Turn-Off Time

MODULE DESCRIPTION

The LT Series transceiver is a low-cost, high-performance synthesized AM / OOK transceiver, capable of transmitting and receiving serial data at up to 10,000bps over line-of-site distances of up to 3,000 feet. Its exceptional receiver sensitivity and highly stable transmitter output result in outstanding range performance. The transceiver is completely self-contained and does not require any additional RF components (except an antenna). This greatly simplifies the design process, reduces time to market, and reduces production assembly and testing costs. The LT is housed in a compact surface-mount package that integrates easily into existing designs and is equally friendly to prototyping and volume production. The module's low power consumption makes it ideal for battery-powered products.

PIN ASSIGNMENTS

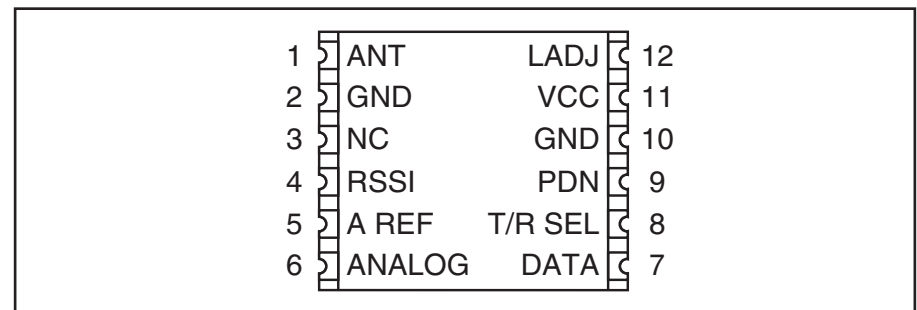

Figure 16: LT Series Transceiver Pinout (Top View)

PIN DESCRIPTIONS

Pin #	Name	Description
1	ANT	50-ohm RF Port
2	GND	Analog Ground
3	NC	No Connection
4	RSSI	Received Signal Strength Indicator. This line will supply an analog voltage proportional to the received signal strength.
5	A REF	Analog RMS (Average) Voltage Reference
6	ANALOG	Recovered Analog Output
7	DATA	Digital Data Line. This line will output the received data when in Receive Mode and is the data input when in Transmit Mode.
8	T/R SEL	Transmit / Receive Select. Pull this line low to place the transceiver into receive mode. Pull it high to place it into transmit mode.
9	PDN	Power Down. Pull this line low or leave floating to place the receiver into a low-current state. The module will not be able to send or receive a signal in this state. Pull high to activate the transceiver.
10	GND	Analog Ground
11	V_{CC}	Supply Voltage
12	LADJ/ V_{CC}	Level Adjust. This line can be used to adjust the output power level of the transmitter. Connecting to V_{CC} will give the highest output, while placing a resistor to V_{CC} will lower the output level (see Figure 3).

Table 2: LT Series Transceiver Pin Descriptions

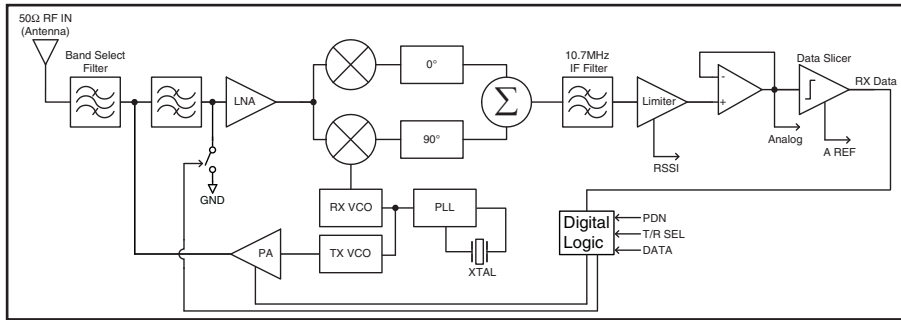

Figure 17: LT Series Transceiver Block Diagram

THEORY OF OPERATION

The LT Series transceiver sends and recovers data by AM or Carrier-Present Carrier-Absent (CPCA) modulation, also referred to as On-Off Keying (OOK). This type of modulation represents a logic low '0' by the absence of a carrier and a logic high '1' by the presence of a carrier. This method affords numerous benefits.

The two most important are: 1) cost-effectiveness due to design simplicity, and 2) higher legally-allowable output power and thus greater range in countries (such as the U.S.) that average output power measurements over time.

The LT's receiver chain utilizes an advanced synthesized superheterodyne architecture and achieves exceptional sensitivity. Transmitted signals enter the module through a 50-ohm RF port intended for single-ended connection to an external antenna. RF signals entering the antenna are filtered and then amplified by an NMOS cascode Low Noise Amplifier (LNA). The signal is then down-converted to a 10.7MHz Intermediate Frequency (IF) by mixing it with a low-side Local Oscillator (LO). The LO frequency is generated by a Voltage Controlled Oscillator (VCO) which is locked by a Phase-Locked Loop (PLL) frequency synthesizer referenced to a precision crystal. The mixer stage is a pair of double-balanced mixers and a unique image rejection circuit, which greatly reduces susceptibility to interference. The IF frequency is further amplified, filtered, and demodulated to recover the original signal. The signal is squared by a data slicer and output on the DATA line.

The LT's transmitter chain is designed to generate up to 10mW of output power into a 50-ohm single-ended antenna while suppressing harmonics and spurious emissions. The transmitter is comprised of a VCO locked by the PLL. The output of the VCO is amplified and buffered by a power amplifier. The amplifier is switched by the incoming data to produce a modulated carrier. The internal digital logic controls a switch that connects the LNA input to ground when in transmit mode, preventing the transmitter from de-sensitizing the receiver. The carrier is filtered to attenuate harmonics, and then output on the 50-ohm RF port.

The transceiver's topology makes the module highly immune to frequency pulling, mismatch, temperature, and other negative effects common to some low-cost architectures. The LT Series design and component quality enable it to outperform many far more expensive transceiver products, making it well-suited for a wide range of consumer and industrial applications.

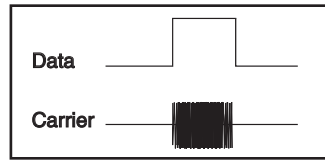

Figure 18: CPCA (AM) Modulation

POWER SUPPLY REQUIREMENTS

The module does not have an internal voltage regulator; therefore it requires a clean, well-regulated power source. While it is preferable to power the unit from a battery, it can also be operated from a power supply as long as noise is less than 20mV. Power supply noise can significantly affect the receiver sensitivity; therefore, providing clean power to the module should be a design priority.

A 10Ω resistor in series with the supply followed by a 10μF tantalum capacitor from V_{CC} to ground will help in cases where the quality of the supply power is poor. Note that the values may need to be adjusted depending on the noise present on the supply line.

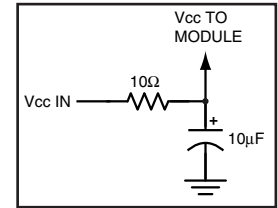

Figure 19: Supply Filter

USING THE PDN LINE

The Power Down (PDN) line can be used to power down the transceiver without the need for an external switch. This line has an internal pull-down, so when it is held low or simply left floating, the module will be inactive.

When the PDN line is pulled to ground, the transceiver will enter into a low-current (~20μA) power-down mode. During this time the transceiver is off and cannot perform any function. It may be useful to note that the startup time coming out of power-down will be slightly less than when applying V_{CC}.

The PDN line allows easy control of the receiver state from external components, such as a microcontroller. By periodically activating the transceiver, sending data, then powering down, the transceiver's average current consumption can be greatly reduced, saving power in battery-operated applications.

Note: If the T/R SEL line is toggled when the transceiver is powered down, internal logic will wake up and increase the current consumption to approximately 350μA. When high, the T/R SEL line will sink approximately 15μA, so the lowest current consumption is obtained by placing the LT into receive mode before powering down.

USING THE RSSI LINE

The transceiver's Received Signal Strength Indicator (RSSI) line serves a variety of functions. This line has a dynamic range of 80dB (typical) and outputs a voltage proportional to the incoming signal strength. It should be noted that the RSSI levels and dynamic range will vary slightly from part to part. It is also important to remember that RSSI output indicates the strength of any in-band RF energy and not necessarily just that from the intended transmitter; therefore, it should be used only to qualify the level and presence of a signal. Using RSSI to determine distance or data validity is not recommended.

The RSSI output can be utilized during testing, or even as a product feature, to assess interference and channel quality by looking at the RSSI level with all intended transmitters shut off. RSSI can also be used in direction-finding applications, although there are many potential perils to consider in such systems. Finally, it can be used to save system power by "waking up" external circuitry when a transmission is received or crosses a certain threshold. The RSSI output feature adds tremendous versatility for the creative designer.

USING THE DATA LINE

The CMOS-compatible DATA line is used for both the transmitter data and the recovered receiver data. Its function is controlled by the state of the T/R SEL line, so it will be an input when in transmit mode and an output when in receive mode. The output is normally connected to a transcoder IC or a microprocessor for data encoding and decoding.

It is important to note that the transceiver does not provide hysteresis or squelching of the DATA line when in receive mode. This means that, in the absence of a valid transmission or transitional data, the DATA line will switch randomly. This is a result of the receiver sensitivity being below the noise floor of the board. This noise can be handled in software by implementing a noise-tolerant protocol as described in Linx Application Note AN-00160. If a software solution is not appropriate, then the transceiver can be squelched.

Squelching will disable the DATA output when the RSSI voltage falls below a reference level. This prevents low amplitude noise from causing the DATA line to switch, reducing hash during times that the transmitter is off or during transmitter steady-state times which exceed 15mS.

The voltage on the A REF line is the analog reference voltage that is used by the transceiver's data circuit. The received signal must be higher than this voltage for the DATA line to activate and must then fall lower than this output for the DATA line to deactivate. This voltage will dynamically follow the midpoint of the received signal's voltage. There is always about 30mVp-p noise riding on the signal's voltage. During times with no carrier or during transmitter steady-state times exceeding 15mS, the reference voltage will reach a point where the noise will cause the output to switch randomly.

To squelch the DATA line, an offset can be added to the A REF line by connecting a resistor to Vcc. This offset will keep the reference voltage above the noise, and quiet the DATA line. Typical resistor values are between 1M Ω and 10M Ω .

Squelching the output will reduce the sensitivity of the receiver and, therefore, the range of the system. For this reason, the squelch threshold will normally be set as low as possible, but the designer can make the compromise between noise level on the DATA line and range of the system. It should also be noted that squelching will cause some bit stretching and contracting, which could affect PWM-based protocols.

It is important to recognize that in many actual use environments, ambient noise and interference may enter the receiver at levels well above the squelch threshold. For this reason, it is always recommended that the product's protocol be structured to allow for the possibility of hashing, even when an external squelch circuit is employed.

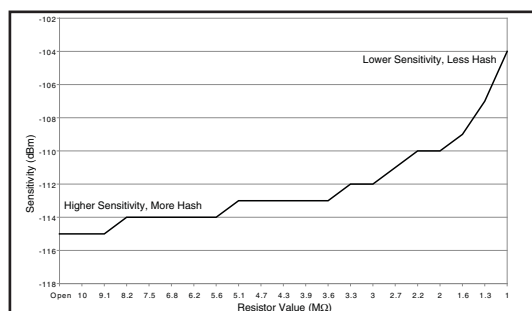

Figure 20: Sensitivity Degradation vs. Squelch Resistor

USING LADJ

The Level Adjust (LADJ) line allows the transceiver's output power to be easily adjusted for range control, lower power consumption, or to meet legal requirements. This is done by placing a resistor between V_{CC} and LADJ. The value of the resistor determines the output power level. When LADJ is connected to V_{CC}, the output power and current consumption will be the highest. Figure 3 shows a graph of the output power vs. LADJ resistance.

This line is very useful during FCC testing to compensate for antenna gain or other product-specific issues that may cause the output power to exceed legal limits. A variable resistor can be temporarily used so that the test lab can precisely adjust the output power to the maximum level allowed by law. The variable resistor's value can be noted and a fixed resistor substituted for final testing. Even in designs where attenuation is not anticipated, it is a good idea to place a resistor pad connected to LADJ and V_{CC} so that it can be used if needed.

For more sophisticated designs, LADJ can also be controlled by a DAC or digital potentiometer to allow precise and digitally-variable output power control.

TRANSFERRING DATA

Once a reliable RF link has been established, the challenge becomes how to effectively transfer data across it. While a properly designed RF link provides reliable data transfer under most conditions, there are still distinct differences from a wired link that must be addressed. The LT Series is intended to be as transparent as possible and does not incorporate internal encoding or decoding, so a user has tremendous flexibility in how data is handled.

If you want to transfer simple control or status signals, such as button presses or switch closures, and your product does not have a microprocessor on board (or you simply wish to avoid protocol development), consider using an encoder and decoder, or a transcoder IC set. These chips are available from a wide range of manufacturers, including Linx. These chips take care of all encoding and decoding functions, and generally provide a number of data pins to which switches can be directly connected. In addition, address bits are usually provided for security and to allow the addressing of multiple units independently. These ICs are an excellent way to bring basic remote control / status products to market quickly and inexpensively. Additionally, it is a simple task to interface with inexpensive microprocessors, or one of many IR, remote control, or modem ICs.

It is always important to separate the types of transmissions that are technically possible from those that are legally allowable in the country of intended operation. Linx Application Notes AN-00125, AN-00128, and AN-00140 should be reviewed, along with Part 15, Section 231 of the Code of Federal Regulations for further details regarding acceptable transmission content in the U.S. All of these documents can be downloaded from our website at www.linxtechnologies.com.

Another area of consideration is that the data structure can affect the output power level. The FCC allows output power in the 260 to 470MHz band to be averaged over a 100mS time frame. Because OOK modulation activates the carrier for a '1' and deactivates the carrier for a '0', a data stream that sends more '0's will have a lower average output power over 100mS. This allows the instantaneous output power to be increased, thus extending range.

PROTOCOL GUIDELINES

While many RF solutions impose data formatting and balancing requirements, Linx RF modules do not encode or packetize the signal content in any manner. The received signal will be affected by such factors as noise, edge jitter, and interference, but it is not purposefully manipulated or altered by the modules. This gives the designer tremendous flexibility for protocol design and interface.

Despite this transparency and ease of use, it must be recognized that there are distinct differences between a wired and a wireless environment. Issues such as interference and contention must be understood and allowed for in the design process. To learn more about protocol considerations, we suggest you read Linx Application Note AN-00160.

Errors from interference or changing signal conditions can cause corruption of the data packet, so it is generally wise to structure the data being sent into small packets. This allows errors to be managed without affecting large amounts of data. A simple checksum or CRC could be used for basic error detection. Once an error is detected, the protocol designer may wish to simply discard the corrupt data or implement a more sophisticated scheme to correct it.

INTERFERENCE CONSIDERATIONS

The RF spectrum is crowded and the potential for conflict with other unwanted sources of RF is very real. While all RF products are at risk from interference, its effects can be minimized by better understanding its characteristics.

Interference may come from internal or external sources. The first step is to eliminate interference from noise sources on the board. This means paying careful attention to layout, grounding, filtering, and bypassing in order to eliminate all radiated and conducted interference paths. For many products, this is straightforward; however, products containing components such as switching power supplies, motors, crystals, and other potential sources of noise must be approached with care. Comparing your own design with a Linx evaluation board can help to determine if and at what level design-specific interference is present.

External interference can manifest itself in a variety of ways. Low-level interference will produce noise and hashing on the output and reduce the link's overall range.

High-level interference is caused by nearby products sharing the same frequency or from near-band high-power devices. It can even come from your own products if more than one transmitter is active in the same area. It is important to remember that only one transmitter at a time can occupy a frequency, regardless of the coding of the transmitted signal. This type of interference is less common than those mentioned previously, but in severe cases it can prevent all useful function of the affected device.

Although technically it is not interference, multipath is also a factor to be understood. Multipath is a term used to refer to the signal cancellation effects that occur when RF waves arrive at the receiver in different phase relationships. This effect is a particularly significant factor in interior environments where objects provide many different signal reflection paths. Multipath cancellation results in lowered signal levels at the receiver and, thus, shorter useful distances for the link.

TYPICAL APPLICATIONS

The LT Series transceiver is ideal for the wireless transfer of serial data, control, or command data. The transceiver does not perform any encoding or decoding of the data, so the designer has a great deal of flexibility in the design of a protocol for the system. The data source and destination can be any device that uses asynchronous serial data, such as a PC or a microcontroller. If the application is for remote control or command, then the easiest solution is to use a remote control encoder and decoder. These ICs provide a number of data lines that can be connected to switches or buttons or even a microcontroller. When a line is taken high on the encoder, a corresponding line will go high on the decoder as long as the address matches. The Linx MT Series transcoder is an encoder and decoder in a single chip which allows bi-directional control and confirmation using a transceiver. The figure below shows a circuit using the Linx LICAL-TRC-MT transcoder.

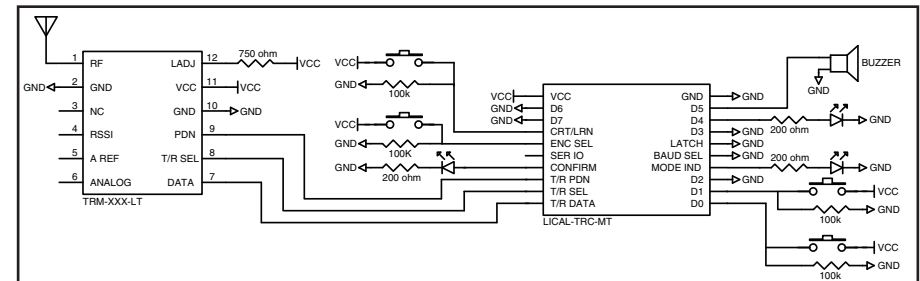

Figure 21: LT Transceiver and MT Transcoder

This circuit uses the LT Series transceiver and the MT Series transcoder to transmit and receive button presses. The MT Series has eight data lines, which can be set as inputs and connected to buttons that will pull the line high when pressed, or set as outputs to activate external circuitry. When not used, the lines are pulled low by 100kΩ resistors. The transcoder will begin a transmission when any of the input data lines are taken high. When a valid transmission is received, the transcoder will activate the appropriate output data lines and then send a confirmation back to the originating transcoder. When the confirmation is received, the originating transcoder will activate its CONFIRM line. In this example, this will turn on an LED for visual indication. The transcoder will automatically control the power to the transceiver via the PDN line and the transmit / receive state via the T/R SEL line.

The MT Series Transcoder Data Guide explains this circuit and the many features of the transcoder in detail, so please refer to that document for more information.

A 750Ω resistor is used on the LADJ line of the transceiver to reduce the output power of the transmitter to meet North American certification requirements. This value may need to be adjusted, depending on antenna efficiency and the power allowed in the country of operation.

BOARD LAYOUT GUIDELINES

If you are at all familiar with RF devices, you may be concerned about specialized board layout requirements. Fortunately, because of the care taken by Linx in designing the modules, integrating them is straightforward. Despite this ease of application, it is still necessary to maintain respect for the RF stage and exercise appropriate care in layout and application in order to maximize performance and ensure reliable operation. The antenna can also be influenced by layout choices. Please review this data guide in its entirety prior to beginning your design. By adhering to good layout principles and observing some basic design rules, you will be on the path to RF success.

The adjacent figure shows the suggested PCB footprint for the module. The actual pad dimensions are shown in the Pad Layout section of this manual. A ground plane (as large as possible) should be placed on a lower layer of your PC board opposite the module. This ground plane can also be critical to the performance of your antenna, which will be discussed later. **There should not be any ground or traces under the module on the same layer as the module, just bare PCB.**

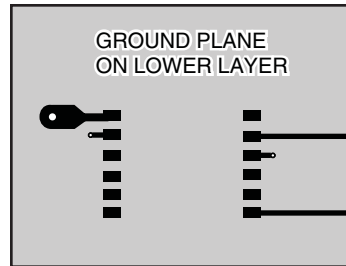

Figure 22: Suggested PCB Layout

During prototyping, the module should be soldered to a properly laid-out circuit board. The use of prototyping or “perf” boards will result in horrible performance and is strongly discouraged.

No conductive items should be placed within 0.15in of the module’s top or sides.

Do not route PCB traces directly under the module. The underside of the module has numerous traces and vias that could short or couple to traces on the product’s circuit board.

The module’s ground lines should each have their own via to the ground plane and be as short as possible.

AM / OOK receivers are particularly subject to noise. The module should, as much as reasonably possible, be isolated from other components on your PCB, especially high-frequency circuitry such as crystal oscillators, switching power supplies, and high-speed bus lines. Make sure internal wiring is routed away from the module and antenna, and is secured to prevent displacement.

The power supply filter should be placed close to the module’s V_{CC} line.

In some instances, a designer may wish to encapsulate or “pot” the product. Many Linx customers have done this successfully; however, there are a wide variety of potting compounds with varying dielectric properties. Since such compounds can considerably impact RF performance, it is the responsibility of the designer to carefully evaluate and qualify the impact and suitability of such materials.

The trace from the module to the antenna should be kept as short as possible. A simple trace is suitable for runs up to 1/8-inch for antennas with wide bandwidth characteristics. For longer runs or to avoid detuning narrow bandwidth antennas, such as a helical, use a 50-ohm coax or 50-ohm microstrip transmission line as described in the following section.

MICROSTRIP DETAILS

A transmission line is a medium whereby RF energy is transferred from one place to another with minimal loss. This is a critical factor, especially in high-frequency products like Linx RF modules, because the trace leading to the module’s antenna can effectively contribute to the length of the antenna, changing its resonant bandwidth. In order to minimize loss and detuning, some form of transmission line between the antenna and the module should be used, unless the antenna can be placed very close (<1/8in.) to the module. One common form of transmission line is a coax cable, another is the microstrip. This term refers to a PCB trace running over a ground plane that is designed to serve as a transmission line between the module and the antenna. The width is based on the desired characteristic impedance of the line, the thickness of the PCB, and the dielectric constant of the board material. For standard 0.062in thick FR-4 board material, the trace width would be 111 mils. The correct trace width can be calculated for other widths and materials using the information below. Handy software for calculating microstrip lines is also available on the Linx website, www.linxtechnologies.com.

$$E_e = \frac{E_r + 1}{2} + \frac{E_r - 1}{2} \cdot \frac{1}{\sqrt{1 + 12d/W}}$$

$$Z_0 = \begin{cases} \frac{60}{\sqrt{E_e}} \cdot \ln\left(\frac{8d}{W} + \frac{W}{4d}\right) & \text{For } \frac{W}{d} \leq 1 \\ \frac{120\pi}{\sqrt{E_e} \cdot \left(\frac{W}{d} + 1.393 + 0.667 \cdot \ln\left(\frac{W}{d} + 1.444\right)\right)} & \text{For } \frac{W}{d} \geq 1 \end{cases}$$

E_r = Dielectric constant of PCB material

Figure 23: Microstrip Formulas

Dielectric Constant	Width/Height (W/d)	Effective Dielectric Constant	Characteristic Impedance
4.80	1.8	3.59	50.0
4.00	2.0	3.07	51.0
2.55	3.0	2.12	48.0

PAD LAYOUT

The following pad layout diagram is designed to facilitate both hand and automated assembly.

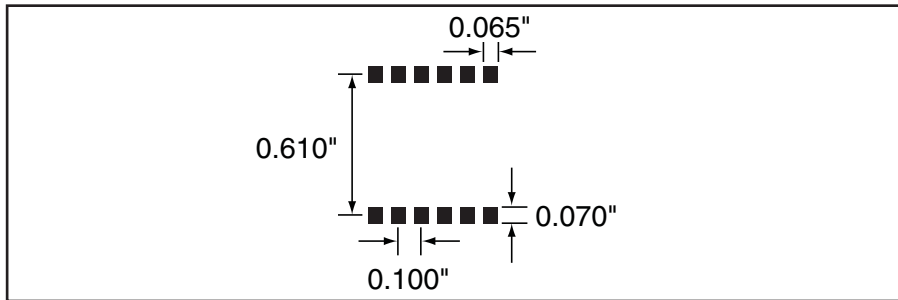

Figure 24: Recommended PCB Layout

PRODUCTION GUIDELINES

The modules are housed in a hybrid SMD package that supports hand or automated assembly techniques. Since the modules contain discrete components internally, the assembly procedures are critical to ensuring the reliable function of the modules. The following procedures should be reviewed with and practiced by all assembly personnel.

HAND ASSEMBLY

Pads located on the bottom of the module are the primary mounting surface. Since these pads are inaccessible during mounting, castellations that run up the side of the module have been provided to facilitate solder wicking to the module's underside. This allows for very quick hand soldering for prototyping and small volume production.

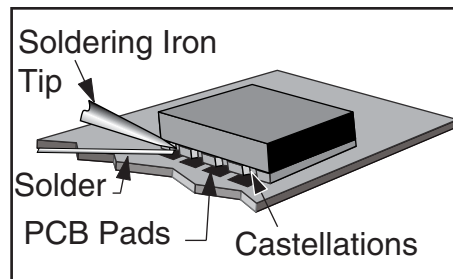

Figure 25: Soldering Technique

If the recommended pad guidelines have been followed, the pads will protrude slightly past the edge of the module. Use a fine soldering tip to heat the board pad and the castellation, then introduce solder to the pad at the module's edge. The solder will wick underneath the module, providing reliable attachment. Tack one module corner first and then work around the device, taking care not to exceed the times listed below.

Absolute Maximum Solder Times

Hand-Solder Temp. TX: +255°C for 10 Seconds

Hand-Solder Temp. RX: +255°C for 10 Seconds

Recommended Solder Melting Point: +218°C

Reflow Oven: +255°C Max. (See adjoining diagram)

AUTOMATED ASSEMBLY

For high-volume assembly, most users will want to auto-place the modules. The modules have been designed to maintain compatibility with reflow processing techniques; however, due to their hybrid nature, certain aspects of the assembly process are far more critical than for other component types.

Following are brief discussions of the three primary areas where caution must be observed.

Reflow Temperature Profile

The single most critical stage in the automated assembly process is the reflow stage. The reflow profile below should not be exceeded, since excessive temperatures or transport times during reflow will irreparably damage the modules. Assembly personnel will need to pay careful attention to the oven's profile to ensure that it meets the requirements necessary to successfully reflow all components while still remaining within the limits mandated by the modules. The figure below shows the recommended reflow oven profile for the modules.

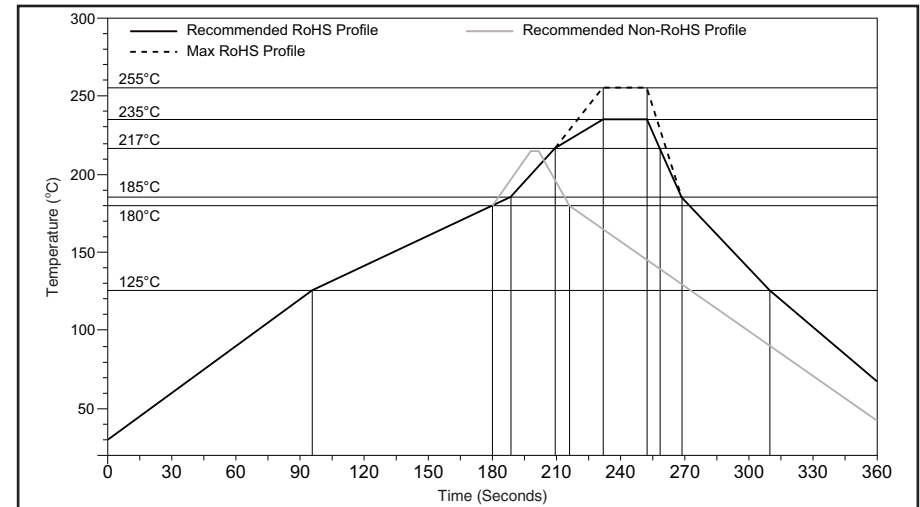

Figure 26: Maximum Reflow Profile

Shock During Reflow Transport

Since some internal module components may reflow along with the components placed on the board being assembled, it is imperative that the modules not be subjected to shock or vibration during the time solder is liquid. Should a shock be applied, some internal components could be lifted from their pads, causing the module to not function properly.

Washability

The modules are wash resistant, but are not hermetically sealed. Linx recommends wash-free manufacturing; however, the modules can be subjected to a wash cycle provided that a drying time is allowed prior to applying electrical power to the modules. The drying time should be sufficient to allow any moisture that may have migrated into the module to evaporate, thus eliminating the potential for shorting damage during power-up or testing. If the wash contains contaminants, the performance may be adversely affected, even after drying.

ANTENNA CONSIDERATIONS

The choice of antennas is a critical and often overlooked design consideration. The range, performance, and legality of an RF link are critically dependent upon the antenna. While adequate antenna performance can often be obtained by trial and error methods, antenna design and matching is a complex task. A professionally designed antenna, such as those from Linx, will help ensure maximum performance and FCC compliance.

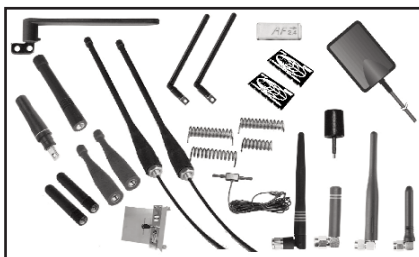

Figure 27: Linx Antennas

Linx transmitters are capable of achieving output power in excess of some legal limits. This allows the designer to use an inefficient antenna, such as a loop trace or helical, to meet size, cost, or cosmetic requirements and still achieve full legal output power for maximum range. If an efficient antenna is used, then some attenuation of the output power will likely be needed. This can easily be accomplished by using the LADJ line or a T-pad attenuator. For more details on T-pad attenuator design, please see Application Note AN-00150.

A receiver antenna should be optimized for the frequency or band in which the receiver operates and to minimize the reception of off-frequency signals. The efficiency of the receiver's antenna is critical to maximizing range performance. Unlike the transmitter antenna, where legal operation may mandate attenuation or a reduction in antenna efficiency, the receiver's antenna should be optimized as much as is practical.

It is usually best to utilize a basic quarter-wave whip until your prototype product is operating satisfactorily. Other antennas can then be evaluated based on the cost, size, and cosmetic requirements of the product. You may wish to review Application Note AN-00500 "Antennas: Design, Application, Performance" and Application Note AN-00501 "Understanding Antenna Specifications and Operation."

GENERAL ANTENNA RULES

The following general rules should help in maximizing antenna performance.

1. Proximity to objects such as a user's hand, body, or metal objects will cause an antenna to detune. For this reason, the antenna shaft and tip should be positioned as far away from such objects as possible.

2. Optimum performance will be obtained from a 1/4- or 1/2-wave straight whip mounted at a right angle to the ground plane. In many cases, this isn't desirable for practical or ergonomic reasons, thus, an alternative antenna style such as a helical, loop, or patch may be utilized and the corresponding sacrifice in performance accepted.

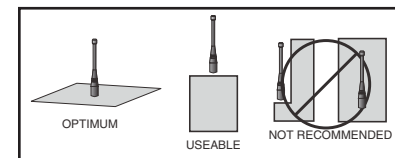

Figure 28: Ground Plane Orientation

3. If an internal antenna is to be used, keep it away from other metal components, particularly large items like transformers, batteries, PCB tracks, and ground planes. In many cases, the space around the antenna is as important as the antenna itself. Objects in close proximity to the antenna can cause direct detuning, while those farther away will alter the antenna's symmetry.

4. In many antenna designs, particularly 1/4-wave whips, the ground plane acts as a counterpoise, forming, in essence, a 1/2-wave dipole. For this reason, adequate ground plane area is essential. The ground plane can be a metal case or ground-fill areas on a circuit board. Ideally, it should have a surface area \geq the overall length of the 1/4-wave radiating element. However, this is often not practical due to size and configuration constraints.

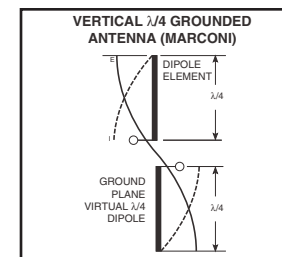

Figure 29: Dipole Antenna

- In these instances, a designer must make the best use of the area available to create as much ground plane as possible in proximity to the base of the antenna. In cases where the antenna is remotely located, or the antenna is not in close proximity to a circuit board, ground plane, or grounded metal case, a metal plate may be used to maximize the antenna's performance.

5. Place the antenna as far as possible from potential interference sources. Any frequency of sufficient amplitude to enter the receiver's front end will reduce system range and can even prevent reception entirely. Switching power supplies, oscillators, or even relays can also be significant sources of potential interference. The single best weapon against such problems is attention to placement and layout. Filter the module's power supply with a high-frequency bypass capacitor. Place adequate ground plane under potential sources of noise to shunt noise to ground and prevent it from coupling to the RF stage. Shield noisy board areas whenever practical.

6. In some applications, it is advantageous to place the module and antenna away from the main equipment. This can avoid interference problems and allows the antenna to be oriented for optimum performance. Always use 50Ω coax, like RG-174, for the remote feed.

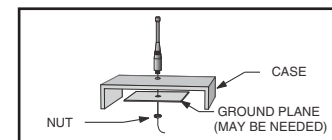

Figure 30: Remote Ground Plane

COMMON ANTENNA STYLES

There are literally hundreds of antenna styles and variations that can be employed with Linx RF modules. Following is a brief discussion of the styles most commonly utilized. Additional antenna information can be found in Linx Application Notes AN-00100, AN-00140, AN-00500, and AN-00501. Linx antennas and connectors offer outstanding performance at a low price.

Whip Style



$$L = \frac{234}{F \text{ MHz}}$$

Where:
L = length in feet of quarter-wave length
F = operating frequency in megahertz

A whip-style antenna provides outstanding overall performance and stability. A low-cost whip is can be easily fabricated from a wire or rod, but most designers opt for the consistent performance and cosmetic appeal of a professionally-made model. To meet this need, Linx offers a wide variety of straight and reduced-height whip-style antennas in permanent and connectorized mounting styles.

The wavelength of the operational frequency determines an antenna's overall length. Since a full wavelength is often quite long, a partial 1/2- or 1/4-wave antenna is normally employed. Its size and natural radiation resistance make it well matched to Linx modules. The proper length for a straight 1/4-wave can be easily determined using the adjacent formula. It is also possible to reduce the overall height of the antenna by using a helical winding. This reduces the antenna's bandwidth, but is a great way to minimize the antenna's physical size for compact applications. This also means that the physical appearance is not always an indicator of the antenna's frequency.

Specialty Styles



Linx offers a wide variety of specialized antenna styles. Many of these styles utilize helical elements to reduce the overall antenna size while maintaining reasonable performance. A helical antenna's bandwidth is often quite narrow and the antenna can detune in proximity to other objects, so care must be exercised in layout and placement.

Loop Style



A loop- or trace-style antenna is normally printed directly on a product's PCB. This makes it the most cost-effective of antenna styles. The element can be made self-resonant or externally resonated with discrete components, but its actual layout is usually product specific. Despite the cost advantages, loop-style antennas are generally inefficient and useful only for short-range applications. They are also very sensitive to changes in layout and PCB dielectric, which can cause consistency issues during production. In addition, printed styles are difficult to engineer, requiring the use of expensive equipment, including a network analyzer. An improperly designed loop will have a high SWR at the desired frequency, which can cause instability in the RF stage.



Linx offers low-cost planar and chip antennas that mount directly to a product's PCB. These tiny antennas do not require testing and provide excellent performance in light of their small size. They offer a preferable alternative to the often-problematic "printed" antenna.

ONLINE RESOURCES



www.linxtechnologies.com

- Latest News
- Data Guides
- Application Notes
- Knowledgebase
- Software Updates



If you have questions regarding any Linx product and have Internet access, make www.linxtechnologies.com your first stop. Our website is organized in an intuitive format to immediately give you the answers you need. Day or night, the Linx website gives you instant access to the latest information regarding the products and services of Linx. It's all here: manual and software updates, application notes, a comprehensive knowledgebase, FCC information, and much more. Be sure to visit often!



www.antennafactor.com

The Antenna Factor division of Linx offers a diverse array of antenna styles, many of which are optimized for use with our RF modules. From innovative embeddable antennas to low-cost whips, domes to Yagis, and even GPS, Antenna Factor likely has an antenna for you, or can design one to meet your requirements.



www.connectorcity.com

Through its Connector City division, Linx offers a wide selection of high-quality RF connectors, including FCC-compliant types such as RP-SMAs that are an ideal match for our modules and antennas. Connector City focuses on high-volume OEM requirements, which allows standard and custom RF connectors to be offered at a remarkably low cost.



LEGAL CONSIDERATIONS

NOTE: Linx RF modules are designed as component devices that require external components to function. The modules are intended to allow for full Part 15 compliance; however, they are not approved by the FCC or any other agency worldwide. The purchaser understands that approvals may be required prior to the sale or operation of the device, and agrees to utilize the component in keeping with all laws governing its use in the country of operation.

When working with RF, a clear distinction must be made between what is technically possible and what is legally acceptable in the country where operation is intended. Many manufacturers have avoided incorporating RF into their products as a result of uncertainty and even fear of the approval and certification process. Here at Linx, our desire is not only to expedite the design process, but also to assist you in achieving a clear idea of what is involved in obtaining the necessary approvals to legally market your completed product.

In the United States, the approval process is actually quite straightforward. The regulations governing RF devices and the enforcement of them are the responsibility of the Federal Communications Commission (FCC). The regulations are contained in Title 47 of the Code of Federal Regulations (CFR). Title 47 is made up of numerous volumes; however, all regulations applicable to this module are contained in Volume 0-19. It is strongly recommended that a copy be obtained from the Government Printing Office in Washington or from your local government bookstore. Excerpts of applicable sections are included with Linx evaluation kits or may be obtained from the Linx Technologies website, www.linxtechnologies.com. In brief, these rules require that any device that intentionally radiates RF energy be approved, that is, tested for compliance and issued a unique identification number. This is a relatively painless process. Linx offers full FCC pre-screening, and final compliance testing is then performed by one of the many independent testing laboratories across the country. Many labs can also provide other certifications that the product may require at the same time, such as UL, Class A / B, etc. Once your completed product has passed, you will be issued an ID number that is to be clearly placed on each product manufactured.

Questions regarding interpretations of the Part 2 and Part 15 rules or measurement procedures used to test intentional radiators, such as Linx RF modules, for compliance with the technical standards of Part 15, should be addressed to:

Federal Communications Commission
Office of Engineering and Technology Laboratory Division
7435 Oakland Mills Road
Columbia, MD 21046-1609

Phone: (301) 362-3000 Fax: (301) 362-3290 E-Mail: labinfo@fcc.gov

International approvals are slightly more complex, although Linx modules are designed to allow all international standards to be met. If you are considering the export of your product abroad, you should contact Linx Technologies to determine the specific suitability of the module to your application.

All Linx modules are designed with the approval process in mind and thus much of the frustration that is typically experienced with a discrete design is eliminated. Approval is still dependent on many factors, such as the choice of antennas, correct use of the frequency selected, and physical packaging. While some extra cost and design effort are required to address these issues, the additional usefulness and profitability added to a product by RF makes the effort more than worthwhile.

ACHIEVING A SUCCESSFUL RF IMPLEMENTATION

Adding an RF stage brings an exciting new dimension to any product. It also means that additional effort and commitment will be needed to bring the product successfully to market. By utilizing premade RF modules, such as the LR Series, the design and approval process is greatly simplified. It is still important, however, to have an objective view of the steps necessary to ensure a successful RF integration. Since the capabilities of each customer vary widely, it is difficult to recommend one particular design path, but most projects follow steps similar to those shown on the right.

In reviewing this sample design path, you may notice that Linx offers a variety of services (such as antenna design and FCC pre-qualification) that are unusual for a high-volume component manufacturer. These services, along with an exceptional level of technical support, are offered because we recognize that RF is a complex science requiring the highest caliber of products and support. "Wireless Made Simple" is more than just a motto, it's our commitment. By choosing Linx as your RF partner and taking advantage of the resources we offer, you will not only survive implementing RF, you may even find the process enjoyable.

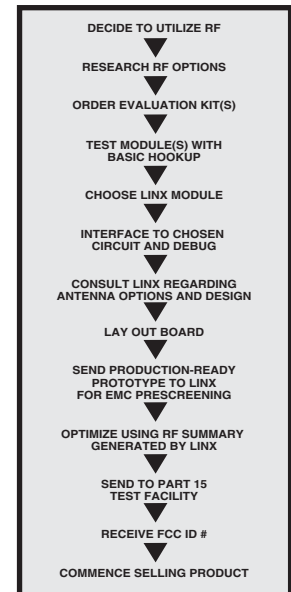

Typical Steps for Implementing RF

HELPFUL APPLICATION NOTES FROM LINX

It is not the intention of this manual to address in depth many of the issues that should be considered to ensure that the modules function correctly and deliver the maximum possible performance. As you proceed with your design, you may wish to obtain one or more of the following application notes, which address in depth key areas of RF design and application of Linx products. These applications notes are available online at www.linxtechnologies.com or by contacting the Linx literature department.

NOTE	APPLICATION NOTE TITLE
AN-00100	RF 101: Information for the RF Challenged
AN-00125	Considerations for Operation within the 260-470MHz Band
AN-00128	Data and Bi-directional Transmissions Under Part 15.231
AN-00130	Modulation Techniques for Low-Cost RF Data Links
AN-00140	The FCC Road: Part 15 From Concept to Approval
AN-00160	Considerations for Sending Data Over a Wireless Link
AN-00500	Antennas: Design, Application, and Performance
AN-00501	Understanding Antenna Specifications and Operation



U.S. CORPORATE HEADQUARTERS

LINX TECHNOLOGIES, INC.

**159 ORT LANE
MERLIN, OR 97532**

**PHONE: (541) 471-6256
FAX: (541) 471-6251
www.linxtechnologies.com**

Disclaimer

Linx Technologies is continually striving to improve the quality and function of its products. For this reason, we reserve the right to make changes to our products without notice. The information contained in this Data Guide is believed to be accurate as of the time of publication. Specifications are based on representative lot samples. Values may vary from lot-to-lot and are not guaranteed. "Typical" parameters can and do vary over lots and application. Linx Technologies makes no guarantee, warranty, or representation regarding the suitability of any product for use in any specific application. It is the customer's responsibility to verify the suitability of the part for the intended application. NO LINX PRODUCT IS INTENDED FOR USE IN ANY APPLICATION WHERE THE SAFETY OF LIFE OR PROPERTY IS AT RISK.

Linx Technologies DISCLAIMS ALL WARRANTIES OF MERCHANTABILITY AND FITNESS FOR A PARTICULAR PURPOSE. IN NO EVENT SHALL LINX TECHNOLOGIES BE LIABLE FOR ANY OF CUSTOMER'S INCIDENTAL OR CONSEQUENTIAL DAMAGES ARISING IN ANY WAY FROM ANY DEFECTIVE OR NON-CONFORMING PRODUCTS OR FOR ANY OTHER BREACH OF CONTRACT BY LINX TECHNOLOGIES. The limitations on Linx Technologies' liability are applicable to any and all claims or theories of recovery asserted by Customer, including, without limitation, breach of contract, breach of warranty, strict liability, or negligence. Customer assumes all liability (including, without limitation, liability for injury to person or property, economic loss, or business interruption) for all claims, including claims from third parties, arising from the use of the Products. The Customer will indemnify, defend, protect, and hold harmless Linx Technologies and its officers, employees, subsidiaries, affiliates, distributors, and representatives from and against all claims, damages, actions, suits, proceedings, demands, assessments, adjustments, costs, and expenses incurred by Linx Technologies as a result of or arising from any Products sold by Linx Technologies to Customer. Under no conditions will Linx Technologies be responsible for losses arising from the use or failure of the device in any application, other than the repair, replacement, or refund limited to the original product purchase price. Devices described in this publication may contain proprietary, patented, or copyrighted techniques, components, or materials. Under no circumstances shall any user be conveyed any license or right to the use or ownership of such items.