

1		
Description	Material	Finish
Nut	Brass	Nickel
Washer	Brass	Nickel
Main Body	Brass	Nickel
Pin Insulator	Teflon	Teflon
Socket	BE CU	Gold
Spacer	Teflon	Teflon
Shield Sleeve	Brass	Nickel
Retaining Nut	Brass	Nickel
Crimp Ring	Brass	Nickel

RECOMMENDED CABLE STRIPPING DIMENSIONS

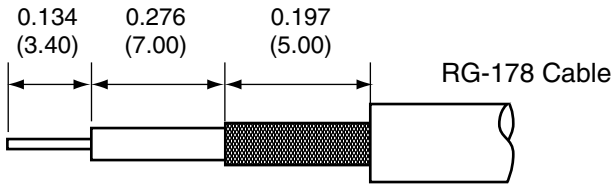

RECOMMENDED MOUNTING HOLE

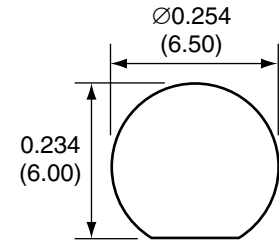

SIDE VIEW

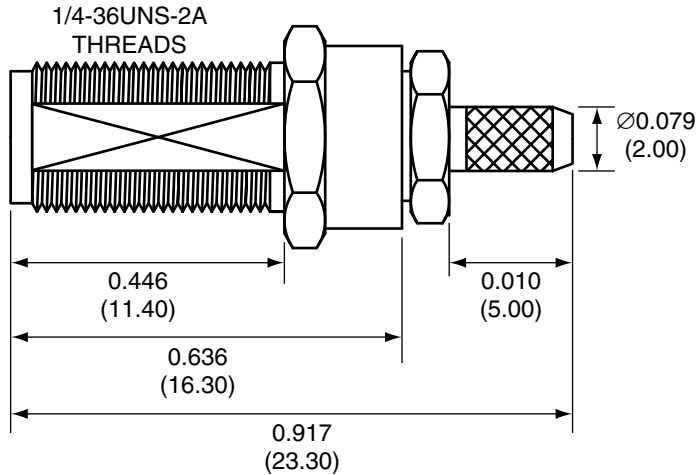

SOCKET

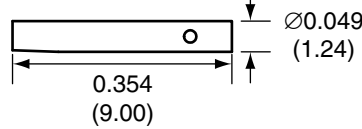

WASHER

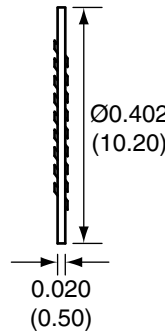

NUT

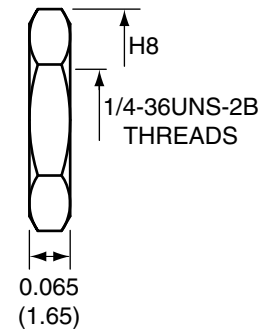

CRIMP RING

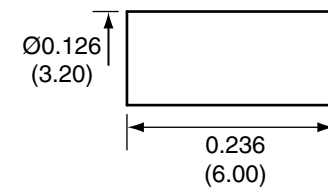

CONREVSMA005 ASSEMBLY INSTRUCTIONS

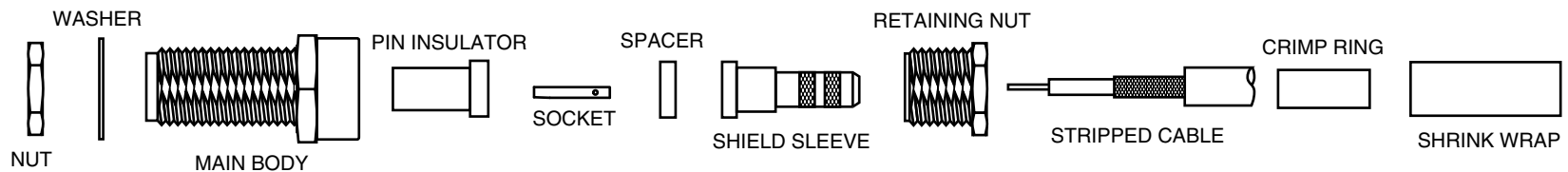

1. Insert the center conductor through the retaining nut, shield sleeve, and spacer.
2. Solder the pin to the center conductor.
3. Insert the pin into the pin insulator, then screw the main body onto the retaining nut.
4. Wrap the braid around the tail of the body and crimp the ring with a hex crimp tool.
5. Use the shrink wrap to cover the crimp ring.
6. Use the nut and washer to secure the connector to a case.

Title SMA FEMALE BULKHEAD MOUNT  
CABLE END CRIMP FOR RG178 CABLE

Part No. CONSMA005-R178 Revision: 1.0

Dimensions: INCHES (mm) Date: 5/29/2007

CONNECTOR CITY  
159 ORT LANE  
MERLIN, OR 97532  
PH (541)-471-6256  
FAX (541)-471-6251

Sheet 1 of 1

**CONNECTOR CITY**  
THE VALUE OF CONNECTIONS